

FLOOR MATERIALS FOR RETAIL FOOD FACILITIES

Where Required	<p>CalCode Section: 114268(a)</p> <p>Floor surfaces in areas where food is prepared, handled, or stored, where utensils are washed, where refuse or garbage is stored, where janitorial facilities are located, in restroom and handwashing areas, shall be constructed of smooth, durable, nonabsorbent material that is easily cleanable.</p> <p>CalCode Section: 114268(b)</p> <p>Floor surfaces shall be coved at the junction of the floor and wall with a 3/8 inch minimum radius coving that extends up the wall at least 4 inches, except in areas where food is stored only in unopened bottles, cans, cartons, sacks, or other original shipping containers.</p>
Unapproved Materials	<p>The following floor materials do not meet the requirements listed under CalCode Section 114268 and are not approved for use.</p> <ul style="list-style-type: none"> • Carpet • Wood or laminate flooring • Wood cove base • Painted concrete • Vinyl composition tile (VCT) • Rubber or vinyl topset cove base
Approved Materials	<p>The following floor materials meet the requirements listed under CalCode Section 114268 and are approved for use.</p> <ul style="list-style-type: none"> • <u>Commercial grade homogeneous sheet vinyl</u> shall have a minimum wear thickness of .08 inches and shall be a solid vinyl product (no felt or fiber backing). Sheet vinyl shall continue up the wall a minimum of 4 inches and shall form an integral 3/8 inch radius cove base at the floor to wall transition. Sheet vinyl shall be installed with heat welded seams and cove stick backing. • <u>Quarry, ceramic, or porcelain tile</u> shall have a minimum tile thickness of 1/4 inch and a maximum grout width of 1/4 inch. Tile flooring shall continue up the wall a minimum of 4 inches and shall form an integral 3/8 inch radius cove at the floor to wall transition. Tile with a smooth surface shall be installed under equipment and on cove base. Tile with an abrasive or raised surface may be installed in walkways only. Floor drains may be required depending on the degree of abrasiveness.

**Approved
Materials
(continued)**

- **Poured or trowled epoxy resin** shall have a minimum finish thickness of 3/16 inch and shall continue up the wall a minimum of 4 inches. Floor to wall transition shall form an integral 3/8 inch radius cove base. Epoxy resin installed below cooking equipment shall be able to withstand hot food spills up to 350°F. Smooth finishes are required under equipment and on cove base. Abrasive finishes may be installed in walkways only. Floor drains may be required depending on the degree of abrasiveness.
- **Concrete** shall be sealed with an approved clear commercial grade penetrating sealer that is resistant to grease, acid, oil, and moisture. **PAINT IS NOT AN ACCEPTABLE SEALER.** Concrete surface must be smooth and free from pits, chips, or exposed aggregate. Cove base shall be either an integral 3/8 inch radius coved concrete curb or “slimfoot” cove base tile. Fabricated 3/8 inch radius metal cove base may be used if samples are provided for approval prior to installation.
- **Walk-in Refrigerators or Freezers** are considered food storage areas and are required to have one of the approved floorings listed above. Screed and topset metal cove base that has been provided by the walk-in manufacturer may be approved for installation along the interior and exterior walls.

**Contact
Information**

County of Sacramento
Environmental Management Department (EMD)
Environmental Health Division
Plan Review Section
10590 Armstrong Ave, Mather, CA 95655
Ph: (916) 874-6010 Fax: (916) 874-6825
Email: emd-ehplanreview@sacounty.net

It is recommended that you contact the Environmental Management Department Plan Review Section for material and installation approval prior to repairing or installing flooring in a retail food facility. Manufacturer product specification sheets and flooring samples may be required.

COVE BASE INSTALLATION EXAMPLES

CORRECT INSTALLATION OF TILE COVE BASE

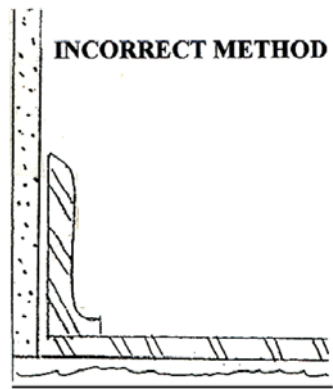
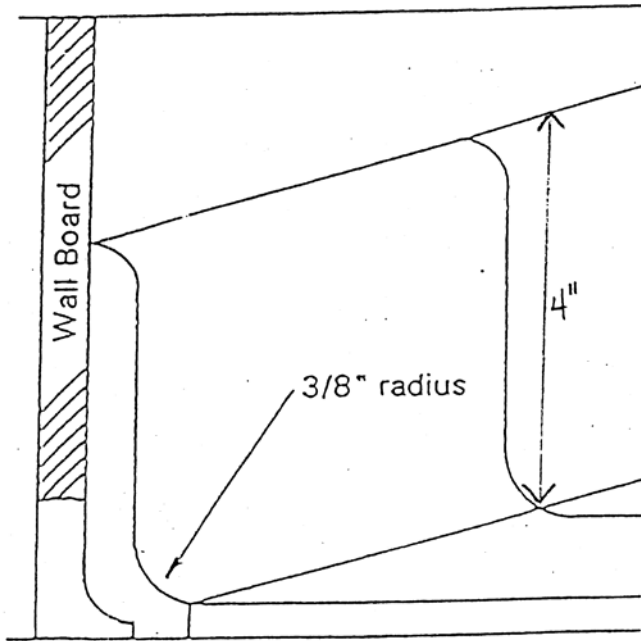

CORRECT INSTALLATION OF SCHLUTER COVE BASE

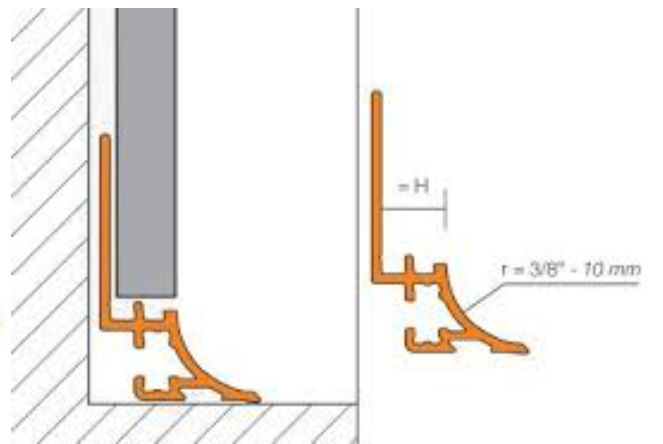
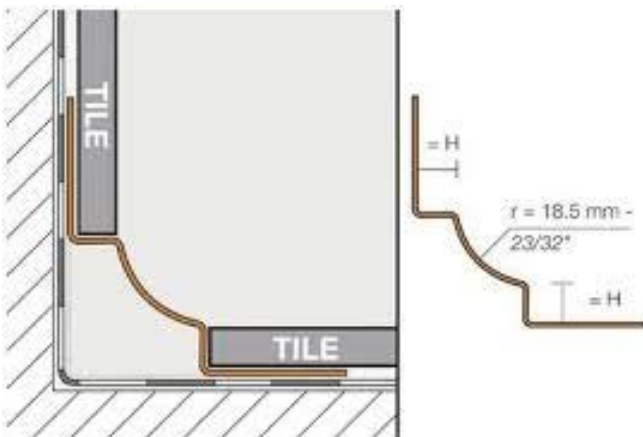

CORRECT INSTALLATION OF SHEET VINYL COVE BASE

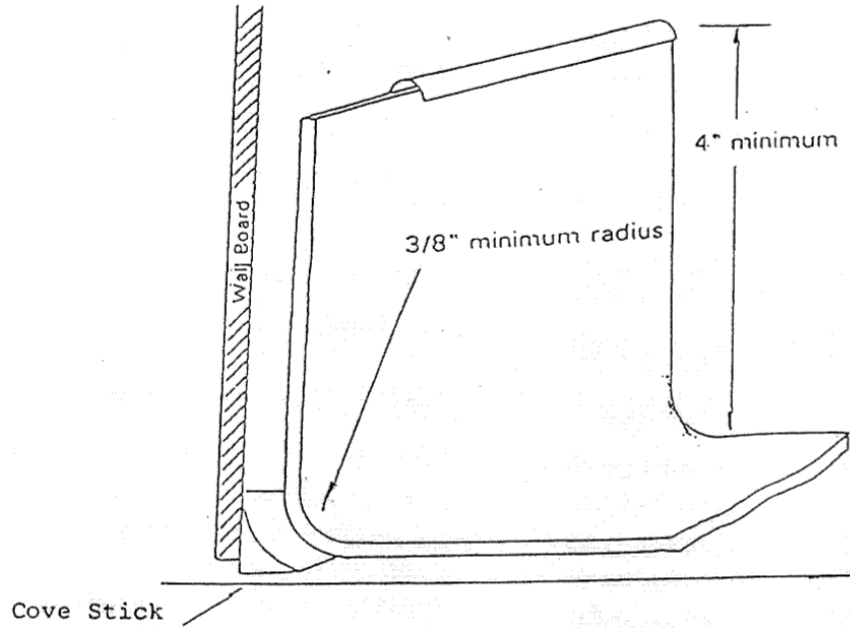

CORRECT INSTALLATION OF SLIMFOOT TILE COVE BASE

Product number S3619T is 6" tile. Product number S3419T is 4" tile.

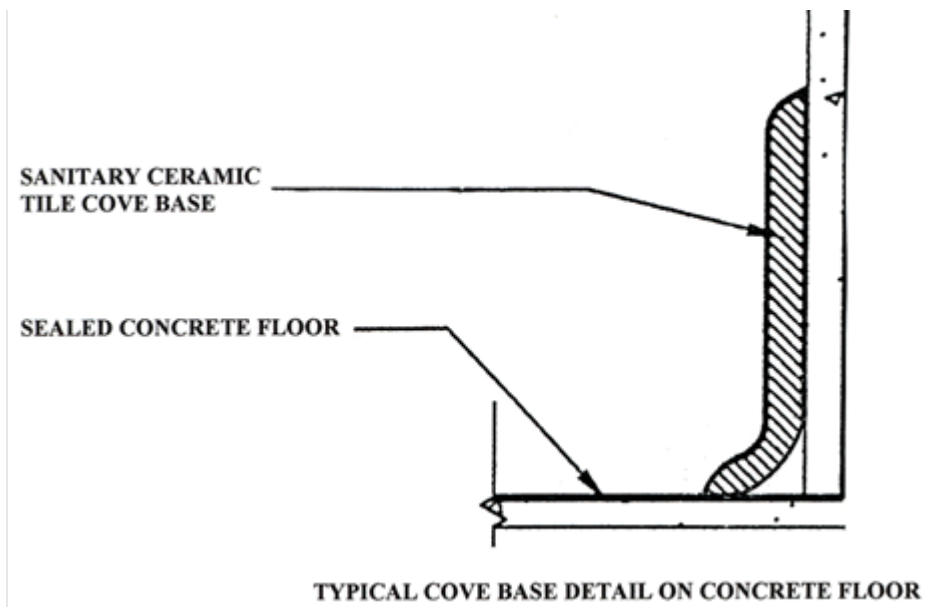

CORRECT INSTALLATION OF COVE BASE UNDER CABINETS

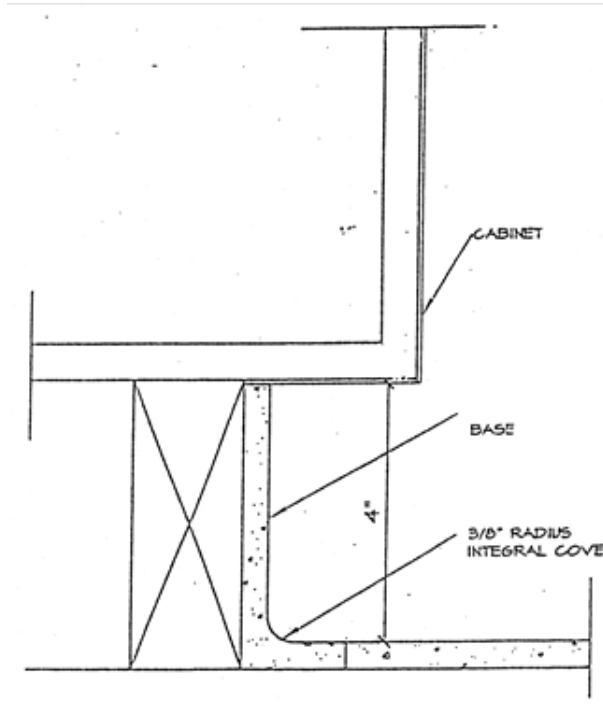

CORRECT INSTALLATION OF SCREED COVE BASE (WALK-INS ONLY)

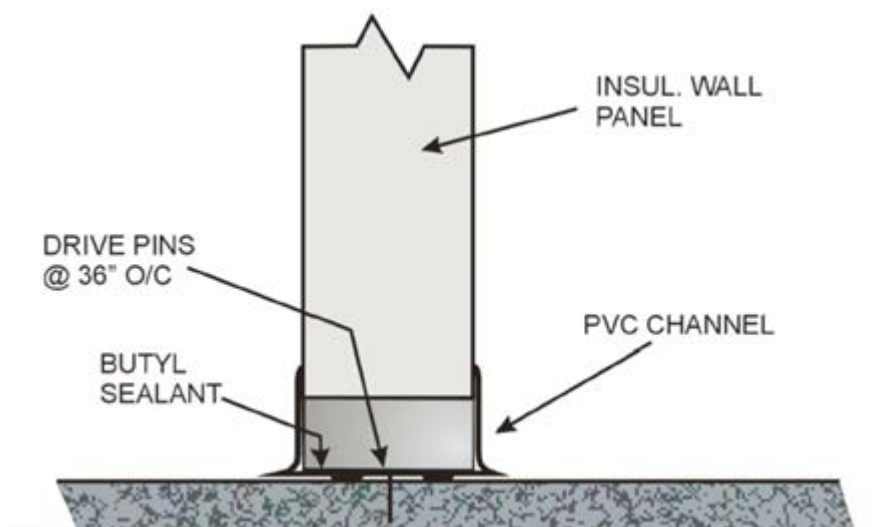

FLOOR MATERIALS REFERENCE SHEET

FLOOR MATERIALS REFERENCE SHEET

APPROVED SHEET VINYL PRODUCTS INCLUDE:

- Armstrong (Medintech or Multitech)
- Mannington (Bio-Spec or Assurance)
- Tarkett (Contractor's Choice Optima, Garnit Elite, or Eminent)

APPROVED CONCRETE SEALERS INCLUDE:

- Quikrete Acrylic Concrete Seal & Cure
- Aqua-Mix
- Rustoleum 6010
- Concrete sealers approved by the USDA for food facilities